



## Monitor Arm System RHMS-13001 / RHMS-13002 User Manual

For apple LED Cinema Display,  
24-inch iMac [aluminum], and  
27-inch iMac & VESA 100/75 Mount

### Supplied Parts and Hardwares

	C-Clamp	M3 Wrench	Hex Tool 4mm	EVA Cushion	Swivel Arm	Monitor Mount	Cable Clip	Dual Stand	Plastic Parts	Flange	Access Card	Hand Screw	Screw	Torx Tool
Parts														
RHMS-13001	1	1	1	1	2	1	1		4	1	1	4	2	1
RHMS-13002	1	2	2	1	4	2	1	1	8	2	2	8	4	1

### Specification

13001		13002
MIS-D(75x75/100x100)	VESA	MIS-D(75x75/100x100)
200mm	LIFT	200mm
0°	ANGLE	0°
360°	PIVOT	360°
360°	SWIVEL	360°
360°	PAN	360°
105°	TILT	105°
400mm	EXTENSION	400mm
0°	VERTICAL	0°
<=14kg or 30.9lbs	Wt. Load	Pole Max load <=20kg or 44lbs

## 1. Apple LED Cinema Display Stand Removal

- ▶ Turn off your iMac and disconnect the power cord and all cables.
- ▶ Turn your iMac so that the back is facing you, and then rotate the top forward until it won't go any further.
- ▶ Release the latch by inserting the access card in the space directly above the top of the stand.
- ▶ The access card should go into the space at a slight upward angle for about 3/4 of an inch (19mm~20mm).
- ▶ If it goes in farther, you've missed the latch, so try again.

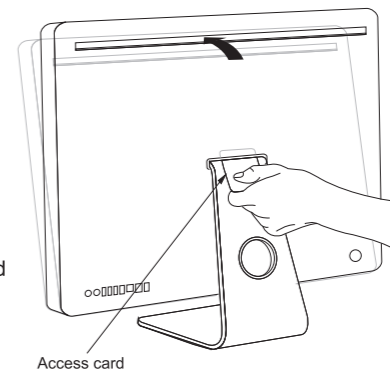

### Important

Use only the access card provided with the kit for this step. Use of any other object or instrument could result in personal injury and/or damage to your iMac. If you have misplaced or damaged the access card, please contact Customer Support for assistance.

- ▶ Rotate your iMac forward another 10 degrees until the 8 screws on top of the stand are visible and the stand is locked in place.

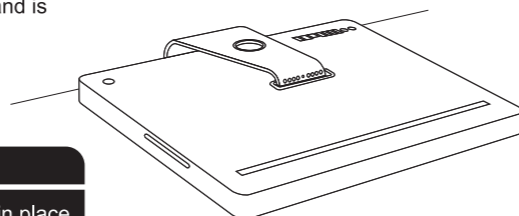

### Important

Keep your iMac upright until the stand is locked in place.

- ▶ To prevent any scratches to your iMac display, lay a soft towel or cloth on a flat surface. Hold the sides of your iMac and carefully lay it down on a flat surface with the display facing down and the stand hanging over the edge of the work area.

## 2. Apple LED Cinema Display Mount Installation

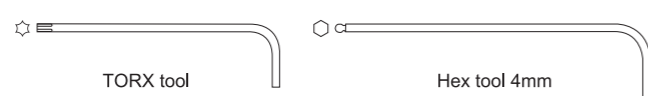

- ▶ Use the TORX tool to remove the 8 screws that attach the stand to the back of your iMac. You'll need these screws to attach the flange to your iMac, so set them aside.

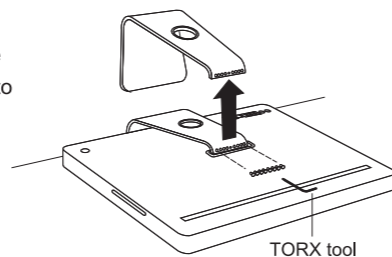

- ▶ Remove the stand and put it in a safe place in case you want to reattach it.

- ▶ Align the hole in the flange with the pin on the back of your iMac, and then use the TORX tool and the 8 screws you removed from the stand to attach the flange.

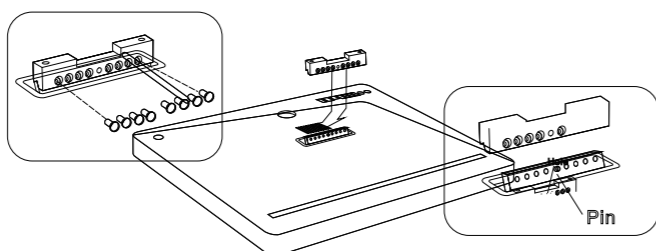

- ▶ Set up the 4 plastic parts to the mount.

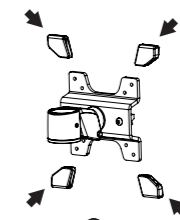

- ▶ Place the mount over the flange.

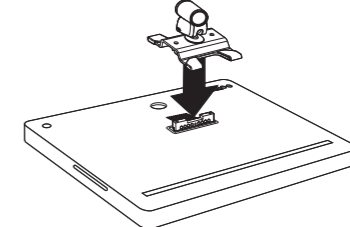

### Important

Keep the flange in the locked position while you attach the mount adapter.

- ▶ Use the Hex tool (4mm) to fasten the screw into the top of the mount.

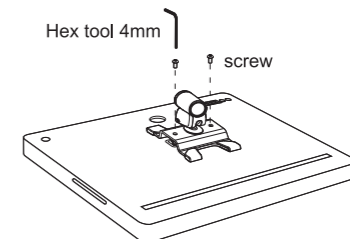

- ▶ After installation of the display mount, you may mount the LCD Cinema Display onto the LCD Arm. For details on how to mount the Display to the LCD arm, please reference the LCD Arm System manual.

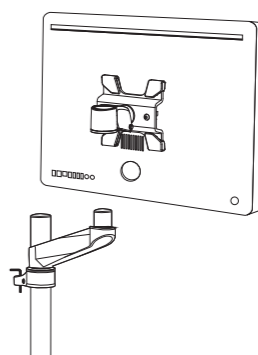

The information has been extracted from the VESA Mount Adapter Install Guide. Please refer to the following website for additional details:  
[http://www.rosewill.com/support/Support\\_Download.aspx](http://www.rosewill.com/support/Support_Download.aspx)

### 3. Transform to VESA Mount (100x100 or 75x75 mm)

▶ Align the back of the display with either the VESA 100x100mm or 75x75mm pre-drilled holes on the display mount.

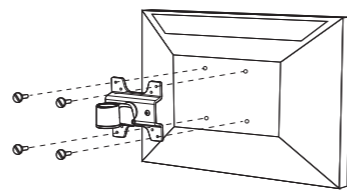

▶ Use the included screws to secure the VESA mount onto the display.

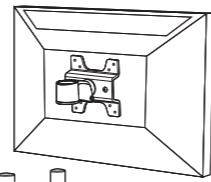

▶ After completion of the VESA Mount installation, mount the display to the LCD Arm. (Please reference the LCD Arm System manual)

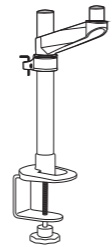

### 4. Installation Method of Mount Type

#### A C-Clamp

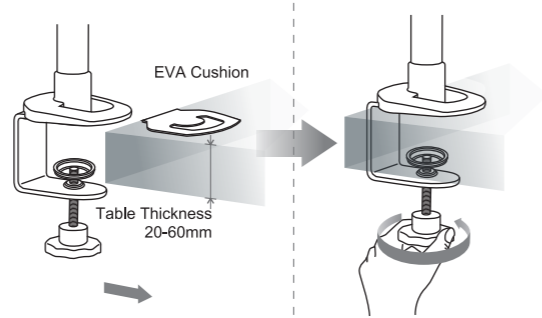

### 5. Install Arms

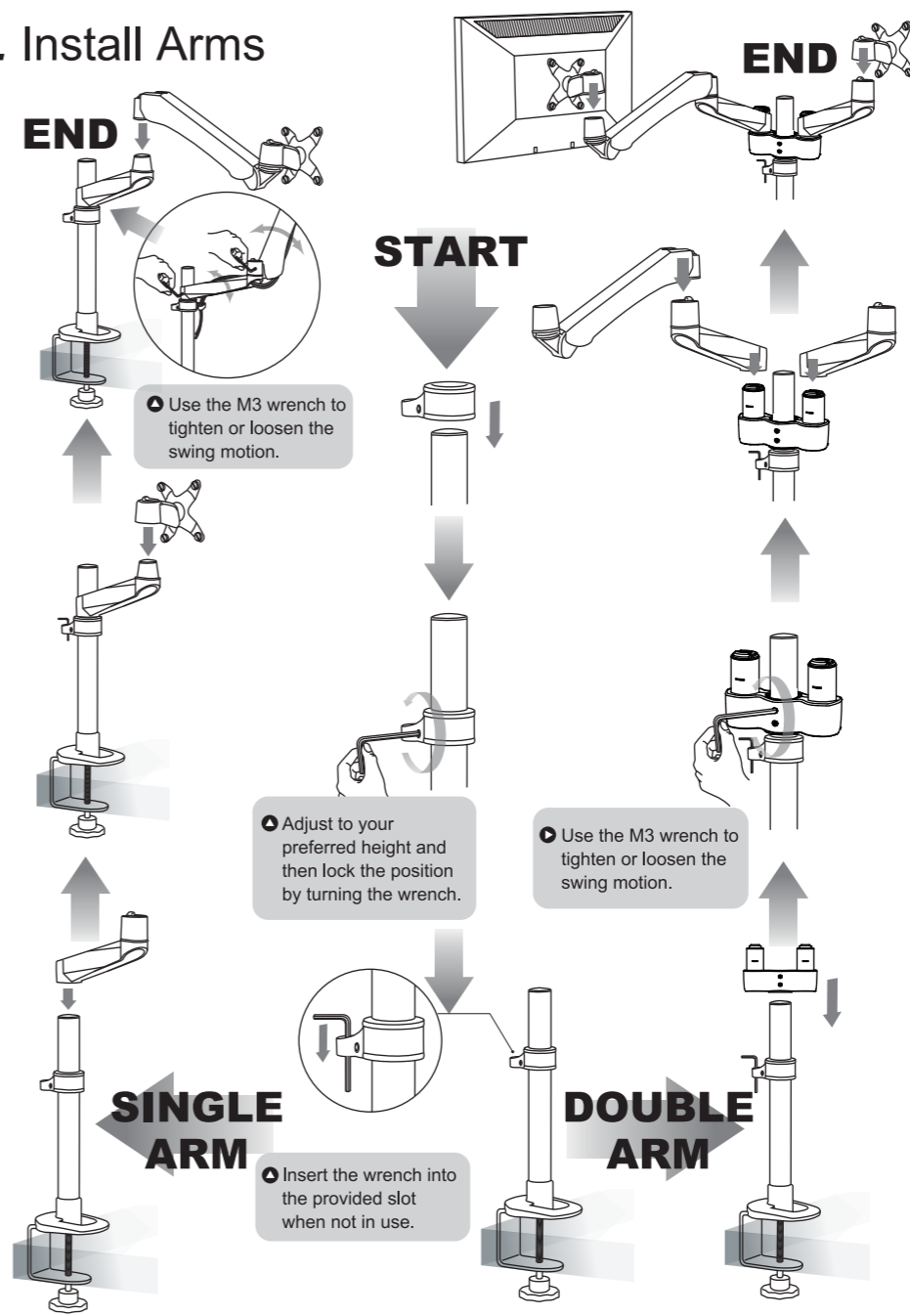

### 6. Install Monitors

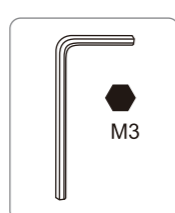
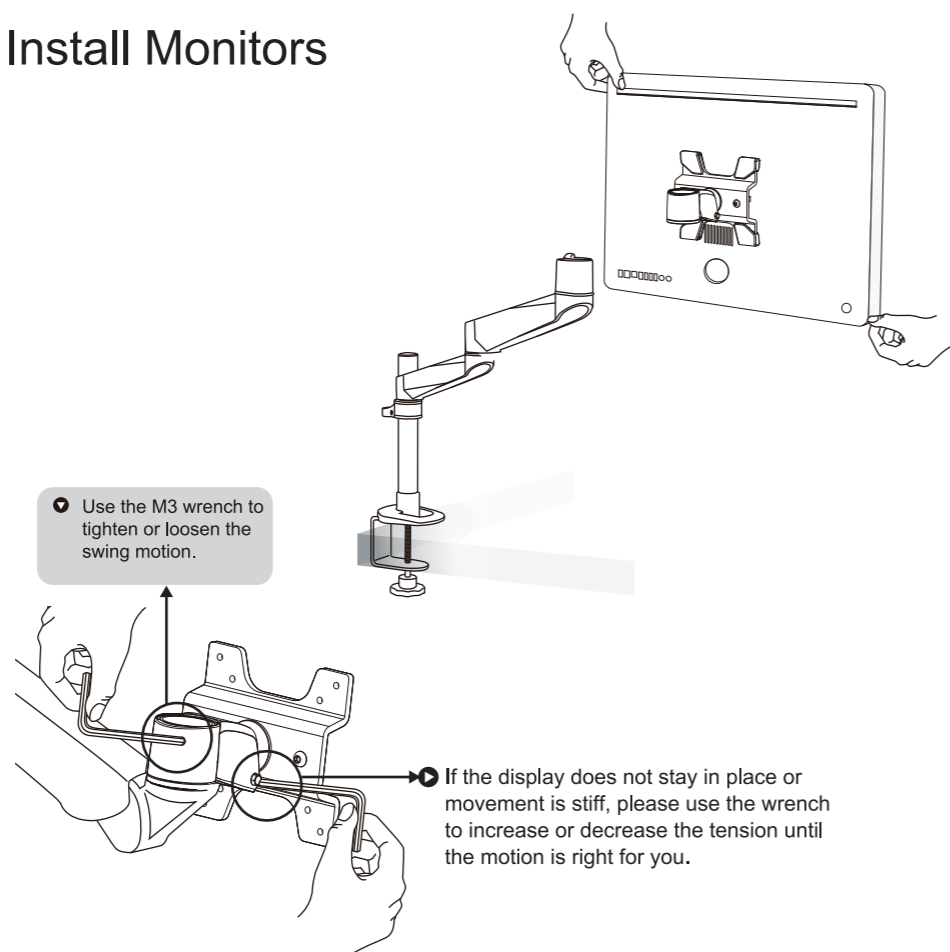

● Increase Tension - Turn Clockwise  
 ● Decrease Tension - Turn Counter Clockwise

### 7. Route Cables

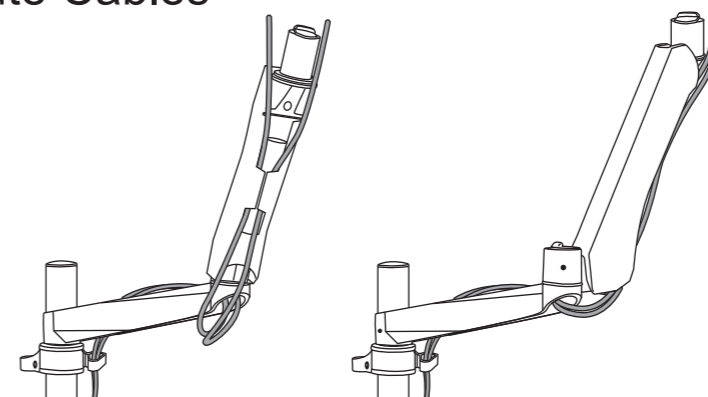

**Rosewill Technical Support information**  
 1-800-575-9885 Monday - Friday 8AM - 5PM PST  
 techsupport@rosewill.com